

EDGE™ AND EDGE GOLD™ FLOOR PANELS

- Quick and Easy Installation
- Strong and Stable
- Self-Gapping
- Warranted Against Delamination



Weyerhaeuser™ **EDGE**™ / Weyerhaeuser™ **EDGE GOLD**™



GIVE YOURSELF AN EDGE ON EVERY JOB



Weyerhaeuser Edge™ oriented strand board (OSB) floor panels help builders get an edge on their competition by delivering both the value and product reliability needed for solid, stable floors. Easily recognized by their green edge seal, each Edge™ panel is uniform in size to allow easy installation, minimal waste, and reduced callbacks. Edge™ floor panels are also backed by a limited 25-year warranty against delamination.



Weyerhaeuser Edge Gold™ OSB has long been the quality builder's floor panel of choice for its outstanding performance and enhanced weather resistance. Engineered to start flat and stay flat, each panel is fully sanded and marked with an easy-to-use fastening template for quick installation.



Edge Gold™ floor panel benefits include:

**No delamination.
No sanding.
We guarantee it.**

- Fully sanded face for uniform thickness
- Limited 200-day no sand guarantee
- Limited 50-year structural warranty
- Stamped with fastener markings for fast nailing
- Tongue-and-groove profiles automatically gap panel edges to the recommended 1/8"
- Bundles delivered face-up for easy handling on the job site
- Proprietary edge seal provides superior edge swell resistance

WHY USE WEYERHAEUSER EDGE™ AND EDGE GOLD™ FLOOR PANELS?

Here's why—

- Self-gapping, tongue-and-groove edges
- Easy installation—panels go down flat and stay flat
- Consistent, reliable performance
- Limited product warranties

The products in this guide are readily available through our nationwide network of distributors and dealers. For more information on other applications or other Weyerhaeuser products, contact your Weyerhaeuser representative.



Certified Sourcing

www.sfiprogram.org
SFI-0008

A GOOD THING IS EVEN BETTER WITH DOWN PORE® Self-Draining Technology

U.S. Patent: 8,333,044

In some regions, Weyerhaeuser Edge Gold™ floor panels include Down Pore® technology, a patent-pending, self-draining feature that allows rainwater to drain from the floor. If your site sees a hard rain after Edge Gold™ flooring is installed, the water is channelled through the panel and off the joists below. No more sweeping off water, no more drilling holes in the floor to let it through, and less time spent waiting for flooring to dry before installing finish material.



**DOWN PORE
SELF-DRAINING
TECHNOLOGY**

Available Sizes

Edge™ and Edge Gold™ floor panels are available at Weyerhaeuser Distribution Centers in standard sizes, and in the following performance classes:

Edge™ floor panels:
19/32", 23/32", 7/8", and 1 1/8"

Edge Gold™ floor panels:
5/8", 23/32", 7/8", and 1 1/8"

Product Specifications

Edge™ and Edge Gold™ floor panels are manufactured in accordance with Voluntary Product Standard PS2, which is recognized by the International Building Code (IBC) and the International Residential Code (IRC).

Down Pore® drainage grooves do not affect the use of Edge Gold™ panels in fire-rated assemblies.

Minimum quantities may be required for some orders. Some thicknesses and Down Pore® technology may not be available in your region.

DESIGN PROPERTIES

In most applications, Edge™ and Edge Gold™ floor panels will be specified based on the span rating of the panel. However, in some uses, engineers will require actual design values to support application-specific engineering calculations. The **Design Values** table below provides industry-standard design values for OSB based on information in the International Building Code (IRC).

The panel design values do not need to be adjusted for panel grade or construction. However, they must be adjusted for duration of load (DOL) and creep when appropriate, and may also require other adjustments that are not shown in this guide. Refer to the current *ASD Manual for Engineered Wood Construction* for applications with elevated moisture or temperatures, applications that require preservative or fire-retardant treatment, or for panels less than 24" in width.

Geometric cross-sectional properties: To calculate the geometric cross-sectional properties for a specific Edge™ or Edge Gold™ panel, use the nominal thickness from the **Design Values** table below and assume a uniform rectangular cross section.

Creep: Under constant load, the deflection of wood-based products generally increases over time—a phenomenon known as creep. In typical applications, with relatively low dead loads, it is not necessary to consider creep in the design process. However, when the potential for creep exists—specifically, when a permanent or constant load will stress the panels to one-half or more of their design strength capacity—an adjustment to the deflection calculations should be made. For Edge™ or Edge Gold™ panels in dry-use conditions, apply the creep adjustment factor ($C_c = 0.50$) to the panel stiffness.

Design Values for Edge™ and Edge Gold™ Floor Panels (100% Load Duration)

| Span rating | | = | 20" o.c. | | 24" o.c. | | 32" o.c. | | 48" o.c. | |
|------------------------------|---|-------------|--------------|-----------|----------|-----------|----------|-----------|-----------|-----------|
| Nominal thickness | | = | 19/32", 5/8" | | 23/32" | | 7/8" | | 1 1/8" | |
| Strength axis ⁽¹⁾ | | = | Primary | Secondary | Primary | Secondary | Primary | Secondary | Primary | Secondary |
| Bending | Moment capacity (lb-in./ft of width) | $F_b S$ | 575 | 250 | 770 | 385 | 1,050 | 685 | 1,900 | 1,200 |
| | Stiffness (lb-in. ² /ft of width) | EI | 210,000 | 40,500 | 300,000 | 80,500 | 650,000 | 235,000 | 1,150,000 | 495,000 |
| Shear | Shear capacity in-the-plane (lb/ft of width) | $F_v(Ib/Q)$ | 205 | 205 | 250 | 250 | 300 | 300 | 385 | 385 |
| | Rigidity through-the-thickness (lb/in. of panel depth) | $G_v t_v$ | 87,000 | 87,000 | 93,000 | 93,000 | 110,000 | 110,000 | 155,000 | 155,000 |
| | Shear capacity through-the-thickness (lb/in. of shear-resisting panel length) | $F_v t_v$ | 195 | 195 | 215 | 215 | 230 | 230 | 305 | 305 |
| Axial | Axial tension capacity (lb/ft of width) | $F_t A$ | 2,900 | 2,100 | 3,350 | 2,550 | 4,000 | 3,250 | 5,600 | 4,750 |
| | Axial compression capacity (lb/ft of width) | $F_c A$ | 4,200 | 4,000 | 5,000 | 4,300 | 6,300 | 6,200 | 8,100 | 6,750 |
| | Stiffness (lb/ft of width x10 ⁶) | EA | 5.00 | 2.90 | 5.85 | 3.30 | 7.50 | 4.20 | 8.20 | 4.60 |

(1) The primary strength axis is the long direction of the panel unless otherwise noted.

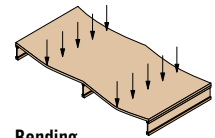

Bending

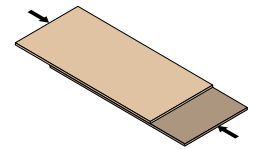

Shear-in-the-Plane (Rolling or Interlaminar Shear)

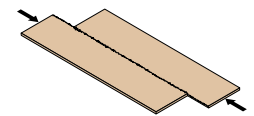

Shear-through-the-Thickness

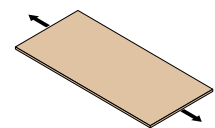

Axial Tension

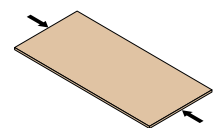

Axial Compression

General Notes

- Table is based on information from the International Building Code (IRC).
- Value must be adjusted for duration of load, creep, elevated moisture or temperature, applications that require preservative or fire-retardant treatment, or for panels less than 24" in width when appropriate. Refer to the current *Manual for Engineered Wood Construction*.
- Values do not need to be adjusted for panel grade or construction.

Nail or Screw Design Values

- Design values for nails or screws used with Edge™ and Edge Gold™ panels can be computed by engineers using the same NDS® procedures used for other structural wood products.
- For withdrawal, use equivalent Specific Gravity (SG) as follows: smooth- or screw-shank nails = 0.40, ring-shank nails = 0.70, wood screws = 0.45.** Design values for nail or screw withdrawal resistance are shown in NDS® Table 11.2B (screws) and Table 11.2C (nails).
- For lateral resistance, use equivalent Specific Gravity (SG) = 0.50.** Design values for nail or screw lateral resistance are found in NDS® Tables 11L (screws) and 11N (nails).

APPLICATION ADJUSTMENT FACTORS

Span Adjustments

| | 2-Span to 1-Span | 3-Span to 1-Span |
|-------------------|------------------|------------------|
| Deflection | 0.42 | 0.53 |
| Moment | 1.00 | 0.80 |
| Shear | 1.25 | 1.20 |

- When adjusting uniform loads based on strength from the **Allowable Uniform Loads** table on page 4, use the span adjustment factor for moment.
- When adjusting uniform loads calculated from the equations on page 5, use the appropriate corresponding factor.

Duration of Load (C_D) (Applies to strength capacities)

| | |
|--------------------------------|------|
| Permanent load (over 10 years) | 0.90 |
| Occupancy live load | 1.00 |
| 2 months, as for snow | 1.15 |
| 7 days | 1.25 |
| Wind or earthquake | 1.60 |
| Impact | 2.00 |

Creep Adjustment Factor (C_c) (For permanent loads)

| Moisture Condition | OSB |
|--------------------|------|
| Dry | 0.50 |

- When a permanent or constant load will stress a panel to ½ or more of its design strength capacity, adjust the deflection calculation by applying the creep adjustment factor (C_c) to the panel stiffness (EI) found above.

SECTION PROPERTIES AND LOAD/SPAN TABLE

Panel Section Properties⁽¹⁾

| | | 19/32" | 5/8" | 23/32" | 3/4" | 7/8" | 1" | 1 1/8" |
|--|------|--------|-------|--------|-------|--------|--------|--------|
| Approximate weight (psf) | = | 2.0 | 2.1 | 2.4 | 2.5 | 2.9 | 3.3 | 3.6 |
| Nominal thickness (in.) | t | 0.594 | 0.625 | 0.719 | 0.750 | 0.875 | 1.000 | 1.125 |
| Area (in. ² /ft) | A | 7.125 | 7.500 | 8.625 | 9.000 | 10.500 | 12.000 | 13.500 |
| Moment of inertia (in. ⁴ /ft) | I | .209 | .244 | .371 | .422 | .670 | 1.000 | 1.424 |
| Section modulus (in. ³ /ft) | S | .705 | .781 | 1.033 | 1.125 | 1.531 | 2.000 | 2.531 |
| Statical moment (in. ³ /ft) | Q | .529 | .586 | .775 | .844 | 1.148 | 1.500 | 1.898 |
| Shear constant (in. ² /ft) | Ib/Q | 4.750 | 5.000 | 5.750 | 6.000 | 7.000 | 8.000 | 9.000 |

Edge™ and Edge Gold™ panels are intended for dry-use applications

(1) Properties based on rectangular cross section of 1' width.

Geometric properties are calculated on a per-foot-of-panel width basis. These properties may be used to find design stresses when required. To do so, divide the design capacity by the applicable section property. You may also calculate the geometric cross-sectional properties for a specific Edge™ or Edge Gold™ panel by using the nominal thickness from the table above and assuming a uniform rectangular cross section.

Allowable Uniform Loads (PSF) for Edge™ and Edge Gold™ Floor Panels (100% Load Duration)

| Span Rating | Nominal Thickness | Load Calculation Based on ⁽¹⁾⁽²⁾ | Span | | | | | | | | | | | | |
|-------------|-------------------|---|---|-------|-------|-----|-----|-----|-----|-----|-----|-----|---|-----|-----|
| | | | Normal Orientation, Strength Axis Perpendicular to Supports | | | | | | | | | | Strength Axis Parallel to Supports ⁽³⁾ | | |
| | | | 12" | 16" | 19.2" | 24" | 30" | 32" | 36" | 40" | 48" | 60" | 12" | 16" | 24" |
| 20" o.c. | 19/32", 5/8" | Deflection | 914 | 344 | 188 | 91 | 45 | 36 | 32 | 23 | 15 | | 175 | 66 | 22 |
| | | Strength | 390 | 270 | 188 | 120 | 77 | 68 | 43 | 35 | 24 | | 210 | 118 | 42 |
| 24" o.c. | 23/32" | Deflection | 1,305 | 491 | 269 | 130 | 64 | 52 | 46 | 33 | 21 | 10 | 351 | 132 | 45 |
| | | Strength | 476 | 345 | 250 | 160 | 102 | 90 | 57 | 46 | 32 | 20 | 323 | 181 | 65 |
| 32" o.c. | 7/8" | Deflection | 2,828 | 1,064 | 582 | 282 | 138 | 113 | 99 | 71 | 46 | 23 | 1,011 | 381 | 128 |
| | | Strength | 571 | 414 | 339 | 218 | 139 | 122 | 77 | 63 | 44 | 28 | 570 | 321 | 114 |
| 48" o.c. | 1 1/8" | Deflection | 5,003 | 1,882 | 1,030 | 499 | 244 | 199 | 175 | 126 | 82 | 40 | 2,158 | 812 | 274 |
| | | Strength | 733 | 531 | 435 | 342 | 256 | 225 | 142 | 115 | 80 | 51 | 733 | 531 | 204 |

(1) Deflection calculation based on L/360 deflection limit. The allowable load for other deflection limits can be computed as follows:

- for L/240 limit, multiply by 1.5
- for L/180 limit, multiply by 2.0
- for L/480 limit, divide by 1.5

(2) Strength calculation based on the minimum of bending or shear.

(3) Values may be increased for Structural 1 sheathing with strength axis parallel to supports. For values based on deflection, multiply by 1.60. For values based on strength, use the equations provided and Structural 1 sheathing design values.

General Notes

- Table is based on:
 - Uniform loads. See PS2 and local building codes for concentrated load and other requirements.
 - Untreated Exposure 1-rated panel in dry conditions.
 - Typical sheathing applications such as floors, walls, and roofs.
 - 2x supports for span configurations less than 48" on-center. Support width effects have been considered.
 - 4x supports for span configurations equal to or greater than 48" on-center. Support width effects have been considered for shear and deflection calculations. Moment calculations do not consider support width effects.
- For **Strength Axis Perpendicular to Supports**:
 - 3-span condition is assumed for spans of 32" or less.
 - 2-span condition is assumed for spans greater than 32".
 - 1-span condition requires the use of the span adjustment factor on page 3.
- For **Strength Axis Parallel to Supports**:
 - 3-span condition is assumed for spans of 16" or less.
 - 2-span condition is assumed for spans of 24".
 - 1-span condition requires the use of the span adjustment factor on page 3.

A Note About Floor Performance

Floor panels are an important component in creating a floor that feels good to customers. The span rating shown on a panel represents a structurally acceptable floor performance level. Floor performance can be enhanced to meet higher customer expectations in several ways:

- Consider using thicker panels.
- Glue and nail flooring for improved connections to help resist vibrations, minimize nail pops, and transfer loads more evenly. Weyerhaeuser recommends using solvent-based subfloor adhesives that meet ASTM D3498 (AFG-01) performance standards. When latex subfloor adhesive is required, careful selection is necessary due to a wide range of performance between brands.
- Use stiffer joists or a narrower joist spacing.

Choosing the optimal combination of these parameters can be difficult. To predict floor performance and evaluate the relationship between the cost and the "feel" of a floor, use Trus Joist® TJ-Pro™ Ratings.

CALCULATING UNIFORM LOADS

One-Span Equations

Uniform load equations based on:

$$\text{Moment Capacity } W_M = \frac{96F_b S}{L_M^2}$$

$$\text{Shear Capacity } W_V = \frac{24F_s(I_b/Q)}{L_V}$$

$$\text{Deflection } W_\Delta = \frac{L_M 921.6 EI}{L_\Delta^4 R}$$

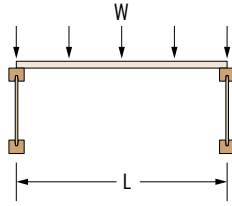

Two-Span Equations

Uniform load equations based on:

$$\text{Moment Capacity } W_M = \frac{96F_b S}{L_M^2}$$

$$\text{Shear Capacity } W_V = \frac{19.2F_s(I_b/Q)}{L_V}$$

$$\text{Deflection } W_\Delta = \frac{L_M 2220 EI}{L_\Delta^4 R}$$

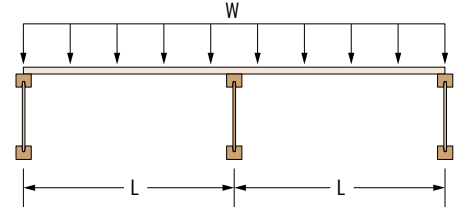

Three-Span Equations

Uniform load equations based on:

$$\text{Moment Capacity } W_M = \frac{120F_b S}{L_M^2}$$

$$\text{Shear Capacity } W_V = \frac{20F_s(I_b/Q)}{L_V}$$

$$\text{Deflection } W_\Delta = \frac{L_M 1743 EI}{L_\Delta^4 R}$$

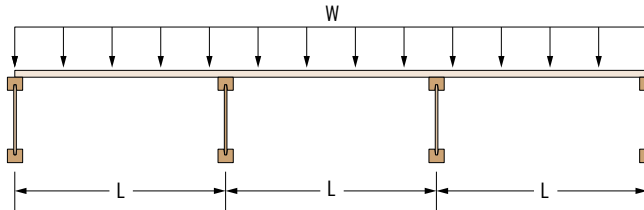

The equations above are based on one-way "beam" action. They are provided to help develop allowable uniform loads based on moment, shear, and deflection as applied to one-, two-, and three-span conditions. Loads derived from the equations provided are assumed to be applied over full-size panels in normal sheathing applications. The following definitions apply:

Δ deflection (in.)

EI design bending stiffness capacity (lb-in.²/ft)

$F_b S$ design moment capacity (lb-in./ft)

$F_s(I_b/Q)$. . . design shear capacity (lb/ft)

L span (in.)

L_M span, center-to-center of supports, used for moment calculation (in.)

L_V clear span, used for shear calculation (in.)

L_Δ clear span plus SW, used for deflection calculations (in.)

R denominator of chosen deflection limit. Example: deflection limit = $L/360$ then $R = 360$

SW support width factor:

– 0.25 for 2x nominal lumber

– 0.625 for 4x nominal lumber

– For additional information refer to the current *Manual for Engineered Wood Construction*

W uniform load (psf)

W_M uniform load based on moment capacity (psf)

W_V uniform load based on shear capacity (psf)

W_Δ uniform load based on deflection (psf)

Example Problem

Find the maximum allowable uniform load (psf) for 24" o.c. span-rated flooring over 16" on-center joists.

Assumptions

- 24" o.c. span-rated flooring
 - Full 4'x8' panel
 - Strength axis perpendicular to joists
 - Use 3-span equations
- Joist Spacing = 16" o.c.
- Joist Width = 1.5"
- Deflection = $L/360$

Locate panel design values for moment, shear, and stiffness on page 3.

Moment capacity (primary) = $F_b S = 770$ lb-in./ft of width

Shear capacity (in-the-plane) = $F_s(I_b/Q) = 250$ lb/ft of width

Stiffness = $EI = 300,000$ lb-in.²/ft of width

1 Calculate Allowable Uniform Load Based on Moment Capacity

$$W_M = \frac{120F_b S}{L_M^2}$$

Calculate appropriate span for moment (center-to-center), $L_M = 16"$

Using: $F_b S = 770$ lb-in./ft and $L_M = 16"$

$$W_M = 120 \times 770 / 16^2$$

$$W_M = 361 \text{ psf}$$

2 Calculate Allowable Uniform Load Based on Shear Capacity

$$W_V = 20F_s(I_b/Q)/L_V$$

Calculate appropriate span for shear (clear span), $L_V = 16" - 1.5" = 14.5"$

Using: $F_s(I_b/Q) = 250$ lb and $L_V = 14.5"$

$$W_V = 20 \times 250 / 14.5$$

$$W_V = 345 \text{ psf}$$

3 Calculate Allowable Uniform Load Based on Deflection

$$W_\Delta = L_M 1743 EI / L_\Delta^4 R$$

$$SW = 0.25 \text{ (from above)}$$

Calculate appropriate span for deflection (clear span + SW),

$$L_\Delta = 14.5" + 0.25" = 14.75"$$

Using: $L_M = 16"$, $R = 360$, and

$$EI = 300,000 \text{ lb-in.}^2/\text{ft}$$

$$W_\Delta = (16 \times 1743 \times 300,000) / (14.75^4 \times 360)$$

$$W_\Delta = 491 \text{ psf}$$

4 Compare Calculated Allowable Uniform Loads

Calculated allowable uniform loads based on strength:

$$W_M = 361 \text{ psf}$$

$$W_V = 345 \text{ psf}$$

$$W_V \text{ controls}$$

Calculated allowable uniform load based on deflection:

$$W_\Delta = 491 \text{ psf}$$

PRODUCT STORAGE AND HANDLING

Like any wood product, wood-based panels are at risk of fungal decay or rot if exposed to repeated wetting or high-moisture environments. Panels that are exposed to such conditions may deteriorate, lose strength, or support mold growth, so protection from these conditions must be provided.

Use a platform made from cull panels and scrap lumber supported by stickers that extend across the width of the stack, and keep panels at least 4" from the ground. Put one sticker in the center of the load and the others approximately 12" from each end. When covering the panels, drape plastic over the ends of the stack and secure it. Then drape plastic over the top and sides of the stack; stake it to the ground, pulling the ends away from the product to allow air circulation along the sides of the stack.

Handle Edge™ and Edge Gold™ panels in a flat orientation. Protect the edges and ends from damage, keep the load level, and lift the stack from the center.

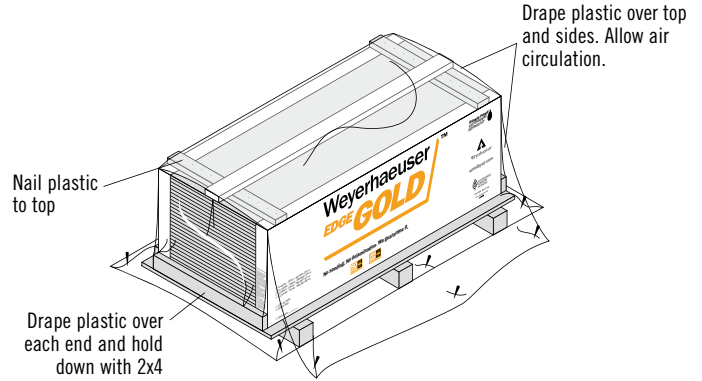

Edge™ and Edge Gold™ panels are intended for dry-use applications

Exposure 1 Bond Classification

Edge™ and Edge Gold™ panels are manufactured to an Exposure 1 bond classification. Exposure 1 panels are suitable for uses where they are not permanently exposed to the weather; they are intended to resist the effects of moisture on structural performance due to construction delays or other conditions of similar severity.

WARNING: Drilling, sawing, sanding or machining wood products generates wood dust. The paint and/or coatings on this product may contain titanium dioxide. Wood dust and titanium dioxide are substances known to the State of California to cause cancer. For more information on Proposition 65, visit wy.com/inform.

PRODUCT WARRANTIES



Visit woodbywy.com/warranty for copies of these and other Weyerhaeuser product warranties.

Contact your local representative or dealer at:

CONTACT US

1.888.453.8358 • woodbywy.com



April 2014 • Reorder OSB-4000

This document supersedes all previous versions. If this is more than one year old, contact your dealer or Weyerhaeuser rep.

▲, Weyerhaeuser, Trus Joist and Down Pore are registered trademarks and Edge, Edge Gold, and TJ-Pro are trademarks of Weyerhaeuser NR. © 2014 Weyerhaeuser NR Company. All rights reserved. Printed in the USA